



# Installation Guide

Indoor Access Point

# CONTENTS

Bahasa Indonesia.....	01
日本語.....	07
繁體中文.....	13
ไทย.....	19
Tiếng Việt.....	25
한국어.....	31

**Catatan:** Gambar mungkin berbeda dari produk yang sebenarnya.

# Topologi Jaringan

## ■ Untuk EAP

Topologi jaringan yang khas untuk EAP ditunjukkan di bawah ini.

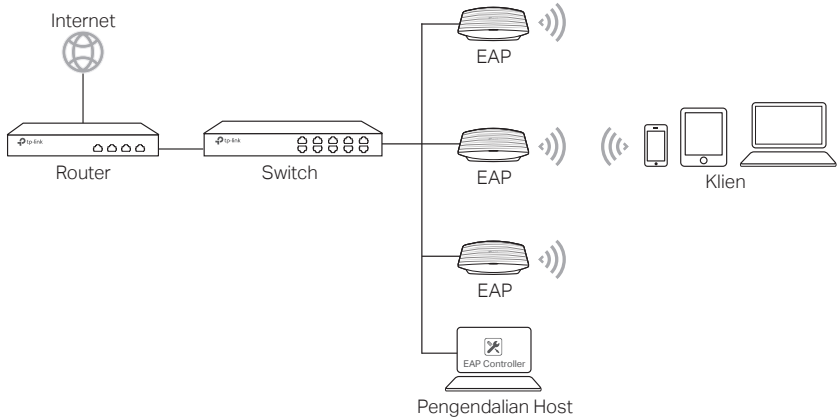

Komputer yang menjalankan perangkat lunak EAP Controller, yang dapat berada dalam subnet yang sama atau berbeda dengan EAP, digunakan untuk mengelola EAP secara terpusat.

Anda bisa mendapatkan perangkat lunak EAP Controller dari situs web kami <https://www.tp-link.com>.

## ■ Untuk CAP (Mode FIT)

Topologi jaringan yang khas untuk CAP ditunjukkan di bawah ini.

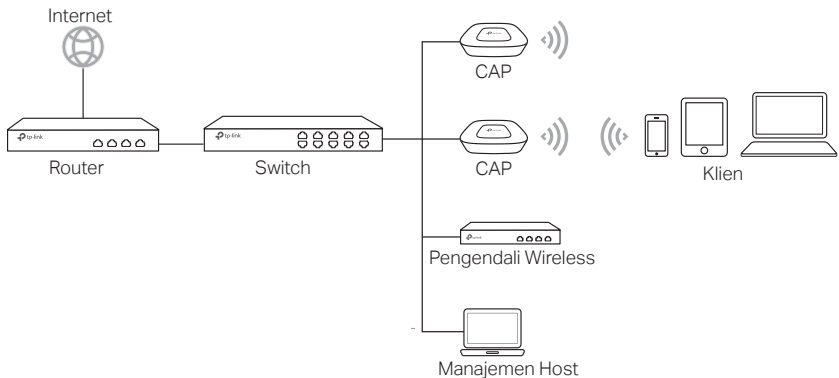

Pengontrol nirkabel bisa berada di subnet yang sama atau berbeda dengan CAPs. Dan manajemen host digunakan untuk masuk ke pengendali nirkabel untuk mengelola CAP secara terpusat.

# Instalasi Perangkat Keras

## ■ Opsi 1: Pemasangan kabel langit-langit

Pemasangan kabel langit-langit hanya untuk perangkat dengan aksesoris berikut. Ikuti langkah-langkah di bawah ini untuk menginstal EAP / CAP dengan aksesoris yang tersedia:

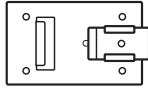

Ceiling T-rail Clip



Sekrup Pan-kepala M3x6 (Qty:5)

- 1 Posisikan Ceiling T-rail Clip dan dorong bagian yang dapat bergerak ke arah rel.

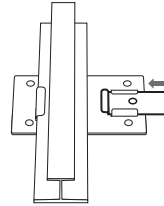

- 2 Gunakan sekrup pan panel M3 x 6 untuk mengamankan klip T-rail ke rel langit-langit.

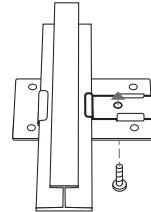

- 3 Pasang braket pemasangan ke Kliring T-Rail Ceiling menggunakan empat sekrup pan-kepala M3x6.

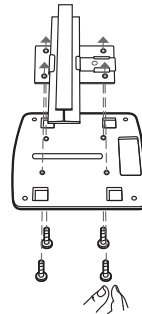

- 4 Pasang EAP / CAP ke braket pemasangan dengan menyelaraskan ARROW 1 (pada EAP / CAP) dengan ARROW 2 (pada braket pemasangan), kemudian putar EAP / CAP searah jarum jam sampai terpasang dengan benar.

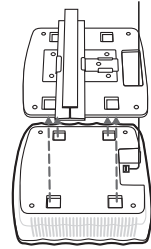

- 5 Sambungkan kabel Ethernet ke port ETHERNET.

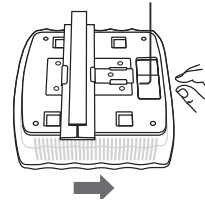

## ■ Opsi 2: Pemasangan di langit-langit

Ikuti langkah-langkah di bawah ini untuk menginstal EAP / CAP dengan aksesoris yang tersedia:



Cincin pipih  
(Qty.3)



Sekrup Pan-kepala M3 × 30  
(Qty.3)



Kacang Sayap  
(Qty.3)

- 1 Lepaskan ubin langit-langit.

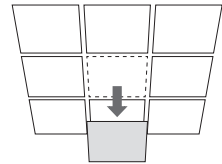

- 2 Tempatkan braket pemasangan di tengah genteng langit-langit. Tandai tiga posisi untuk lubang sekrup dan posisi lubang kabel Ethernet. Bor tiga lubang diameter 4mm untuk sekrup dan lubang diameter 25mm untuk kabel Ethernet pada posisi yang ditandai.

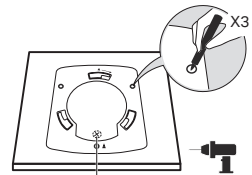

Lubang untuk kabel Ethernet

- 3 Amankan braket pemasangan ke ubin langit-langit menggunakan tiga sekrup pan-kepala M3x30, cincin pipih dan kacang sayap.

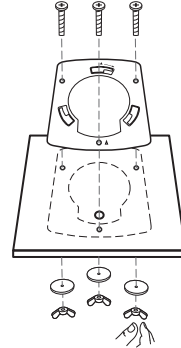

- 4 Umpan kabel Ethernet melalui lubang dan pasang kembali genteng langit-langit ke tempatnya.

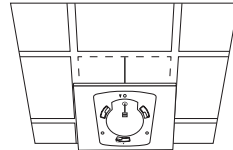

- 5 Sambungkan kabel Ethernet ke port ETHERNET. Pasang EAP / CAP ke braket pemasangan dengan menyelaraskan tanda panah pada EAP / CAP dengan tanda panah pada braket pemasangan, lalu putar EAP / CAP sampai terkunci pada tempatnya.

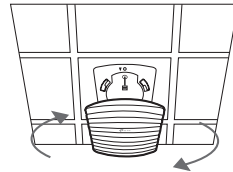

### ■ Opsi 3: Pemasangan di dinding

Ikuti langkah-langkah di bawah ini untuk menginstal EAP / CAP dengan aksesoris yang tersedia:



M3 x 28 Jangkar Dinding Plastik  
(Qty.3)



Sekrup Self-Tapping M3x20  
(Qty.3)

- 1 Jika kabel Ethernet Anda masuk melalui dinding, Anda dapat memasang braket pemasangan untuk membuat kabel melalui lubang pemasangan. Tandai tiga posisi untuk lubang sekrup dan kemudian bor tiga lubang diameter 6mm pada posisi yang ditandai.

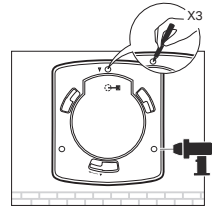

- 2 Masukkan jangkar dinding plastik ke dalam lubang diameter 6mm.

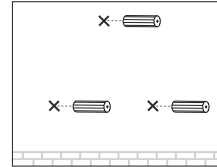

- 3 Amankan braket pemasangan ke dinding dengan menggerakkan sekrup penyadapan diri ke dalam jangkar. Pastikan bahu dari braket pemasangan ada di bagian luar.

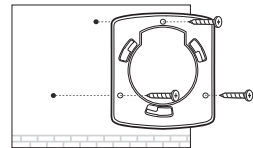

- 4 Sambungkan kabel Ethernet ke port ETHERNET pada EAP / CAP.

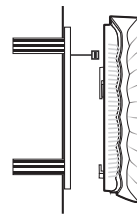

- 5 Pasang EAP / CAP ke braket pemasangan dengan menyelaraskan tanda panah pada EAP / CAP dengan tanda panah pada braket pemasangan, lalu putar EAP / CAP sampai terkunci pada tempatnya.

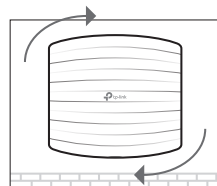

# Sumber Daya Listrik

## ■ Power melalui Perangkat PSE atau Power Adapter

Jika produk dilengkapi dengan power adapter, nyalakan perangkat melalui perangkat PSE (seperti tombol PoE) atau adaptor daya.

### Melalui PoE Switch

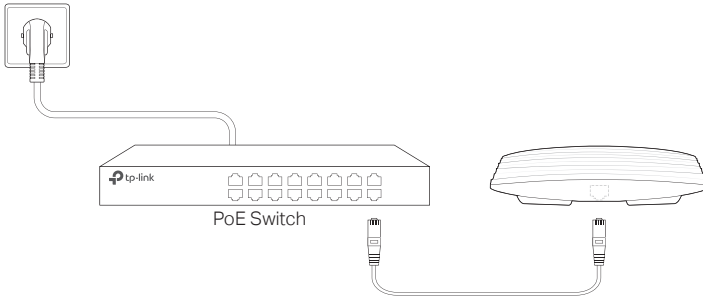

### Melalui Power Adapter

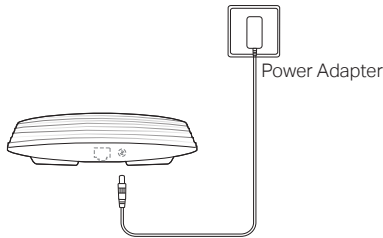

## ■ Power melalui POE Adapter

Jika produk dilengkapi POE Adapter, nyalakan perangkat ini melalui POE Adapter.

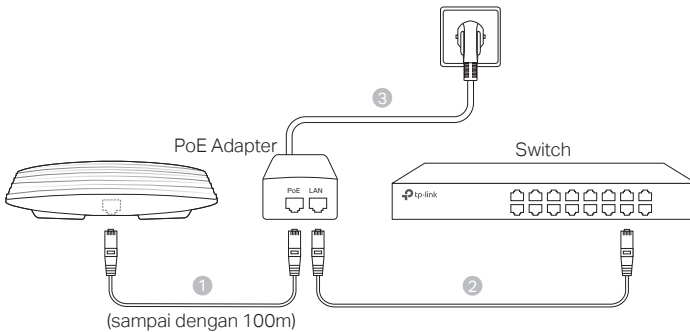



注：画像は実際の商品と異なる場合があります。

# ネットワークトポロジー

## ■ EAP の場合

以下は一般的な EAP のネットワークトポロジーです。

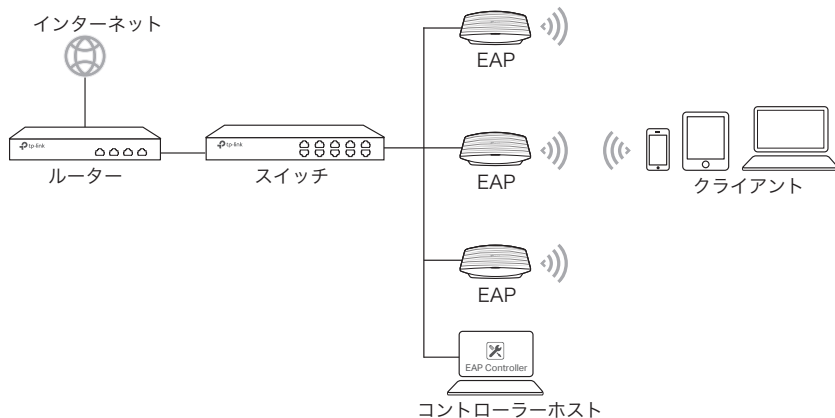

EAP と同じサブネットまたは異なるサブネットにある EAP コントローラソフトウェアを実行しているコンピュータは、EAP を集中管理するために使用されます。

EAP コントローラ ソフトウェアはウェブサイトからダウンロードすることが可能です。

## ■ CAP(FIT モード) の場合

以下は一般的な CAP のネットワークトポロジーです。

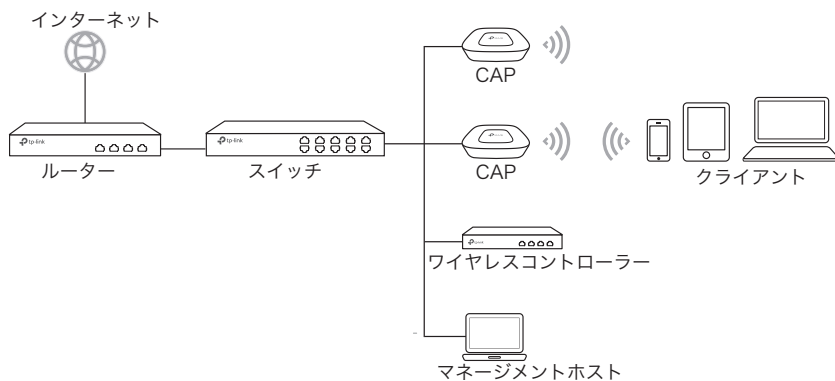

ワイヤレスコントローラーは、CAP と同じサブネットまたは異なるサブネットにあることができます。管理ホストは、CAP を集中管理するためにワイヤレスコントローラーにログインするために使用されます。

# ハードウェアのインストール

## ■ オプション 1: シーリングレールへの取り付け

以下のアクセサリが付属している場合はシーリングレールへの取り付けが可能です。以下の手順に従ってEAP/CAPのインストールを行ってください。

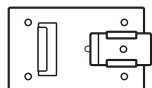

シーリング Tレール クリップ



M3x6 皿ネジ (5 個)

- 1 シーリング Tレールクリップを設置し、可動部をレールベースの方に押しします。

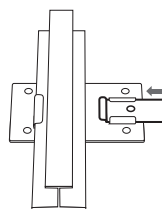

- 2 M3x6 の皿ネジを使用して、Tレールクリップを天井レールに固定します。

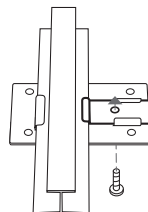

- 3 マウントブラケットを天井の Tレールクリップに 4本の M3x6 皿ネジを使用して取り付けます。

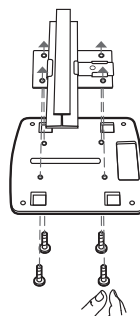

- 4 ARROW 1(EAP / CAPの場合)をARROW 2(取り付けブラケットの上)に合わせてEAP / CAPを取り付けブラケットに取り付け、EAP / CAPを所定の位置にロックされるまで時計方向に回します。

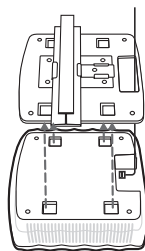

- 5 ETHERNET ポートに LAN ケーブルを接続します。

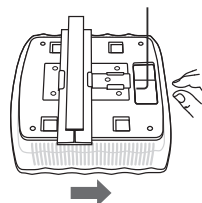

## ■ オプション 2 : 天井への取り付け

以下の手順に従い付属のアクセサリを使用して EAP / CAP をインストールしてください。



ワッシャー  
(3 個)



M3x30 皿ネジ  
(3 個)



ウイングナット (3 個)

- 1 天井のタイルを取り外します。

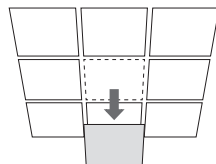

- 2 天井タイルの中央に取り付けブラケットを設置します。ネジ穴の位置と LAN ケーブルの穴の位置を 3 つマークします。ネジ用の直径 4mm の穴 3 個と、イーサネットケーブル用の直径 25mm の穴を、マークされた位置にあけます。

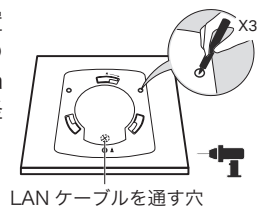

- 3 3つの M3x30 雲台ネジ、ワッシャー、ウイングナットを使用して、取り付けブラケットを天井タイルに固定します。

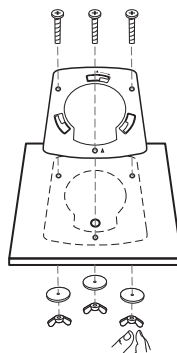

- 4 LAN ケーブルを穴に通し、天井タイルを元の位置に戻します。

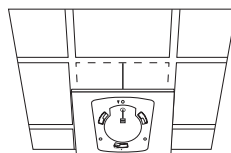

- 5 LAN ケーブルを ETHERNET ポートに接続します。EAP / CAP の矢印マークを取り付けブラケットの矢印と合わせて、EAP / CAP を取り付けブラケットに取り付け、EAP / CAP を所定の位置に固定するまで回転させます。

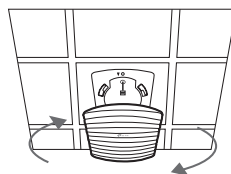

## ■ オプション 3: 壁への取り付け

以下の手順に従って EAP/CAP を設置してください。



M3x28 プラスチック壁用アンカー  
(3 個)



M3x20 セルフタッピングネジ  
(3 個)

- 1 LAN ケーブルが壁を通して給電されている場合は、固定ブラケットを固定穴に通してケーブルを通すことができます。ネジ穴の3つの位置にマークを付け、マークされた位置に直径6mmの穴を3つあけます。

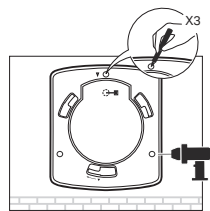

- 2 プラスチックの壁用アンカーを直径6mmの穴に挿入します。

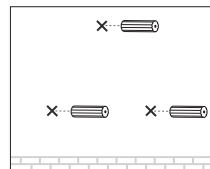

- 3 セルフタッピングネジをアンカーに押し込んで、マウントブラケットを壁に固定します。取り付けブラケットの“肩”が外側にあることを確認します。

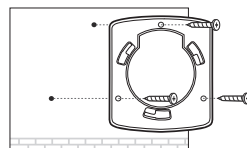

- 4 EAP/CAPのETHERNETポートにLANケーブルを接続します。

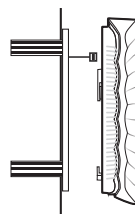

- 5 EAP / CAPの矢印マークを取り付けブラケットの矢印と合わせて、EAP / CAPを取り付けブラケットに取り付け、EAP / CAPを所定の位置に固定するまで回転させます。

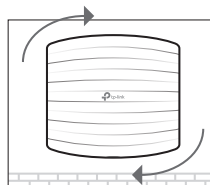

# 電源

## ■ PSE デバイスまたは電源アダプタ経由の電源

製品に電源アダプタが付属している場合は、PSE デバイス（PoE スイッチなど）または電源アダプタを介してデバイスに電源を供給してください。

### PoE スイッチ経由

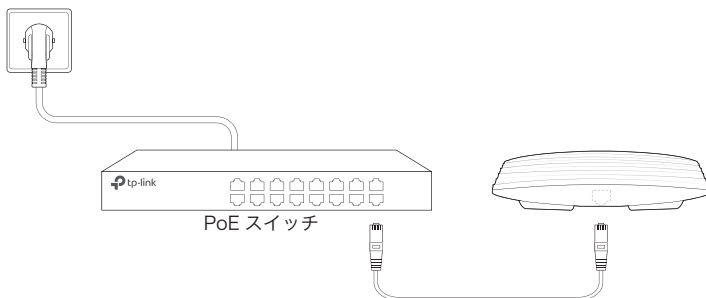

### 電源アダプター経由

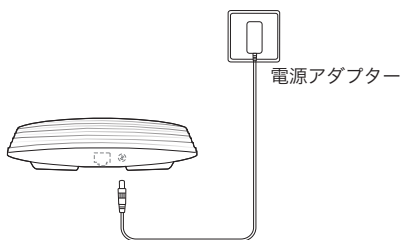

## ■ PoE アダプター経由

製品に POE アダプタが付属している場合は、POE アダプタを介してデバイスに電源を供給してください。

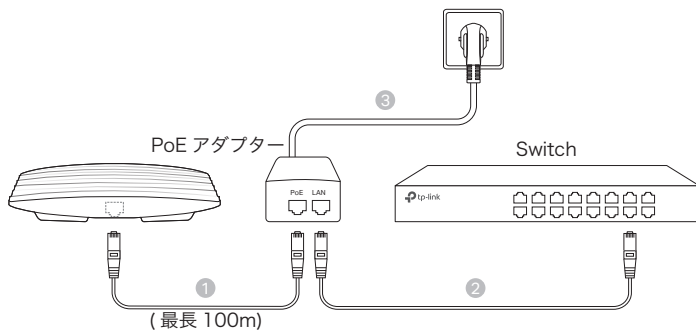

註：此圖片可能與實際產品不同。

# 網路拓撲

## ■ 適用於 EAP

EAP 的典型網路拓撲如下所示。

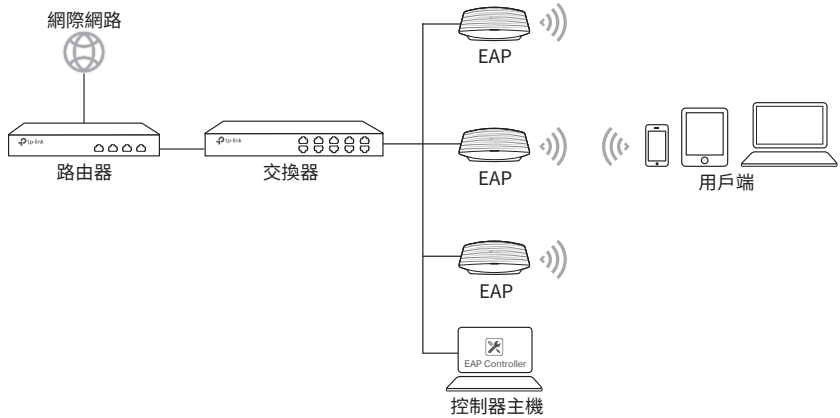

運行 EAP 控制器軟體的電腦 ( 可以與 EAP 在相同或不同的子網中 )，用於集中管理 EAP。

您可以從我們的網站 (<https://www.tp-link.com>) 取得 EAP 控制器軟體。

## ■ 適用於 CAP(FIT 模式)

CAP 的典型網路拓撲如下所示。

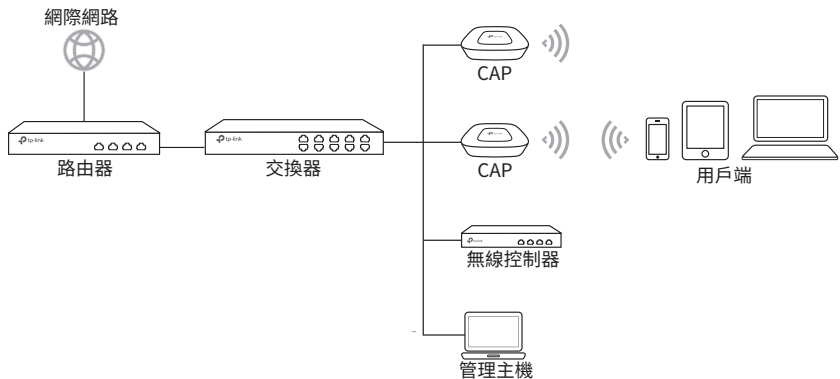

無線控制器可以與 CAP 在相同或不同的子網中。管理主機用於登入無線控制器以集中管理 CAP。

# 硬體安裝

## ■ 選項一：吸頂軌道安裝

吸頂軌道安裝僅適用於具有以下配件的設備。請使用提供的配件，按照以下步驟安裝 EAP / CAP：

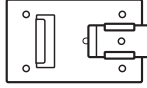

吸頂 T-軌夾



M3×6 盤頭螺釘 (Qty.5)

- 1 安置吸頂 T-軌夾並向著軌基推動可移動的部分。

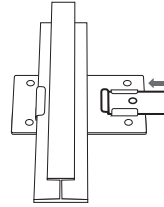

- 2 使用 M3×6 盤頭螺釘，將 T-軌夾固定到天花板軌道上。

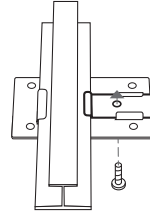

- 3 使用四個 M3x6 盤頭螺釘，將安裝支架裝到吸頂 T-軌夾。

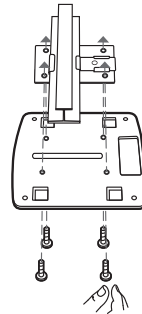



- 4 透過對準箭頭 2（在安裝支架）與箭頭 1（在 EAP/CAP），連接 EAP/CAP 到安裝支架，然後順時針旋轉 EAP/CAP，直到它鎖定到位。

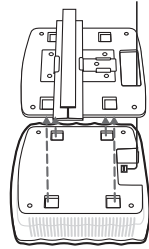

- 5 將乙太網路線連接到乙太網連接埠。

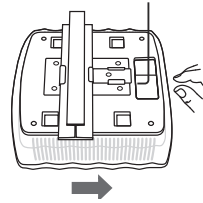

## ■ 選項二：吸頂安裝

請按照下面的步驟與所提供的配件安裝 EAP/CAP：



墊片  
(Qty.3)



M3 x 30 盤頭螺釘  
(Qty.3)



翼狀核心  
(Qty.3)

- 1 移除吸頂板。

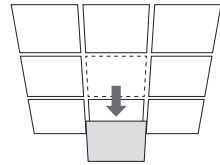

- 2 放置安裝支架中到天花板瓦片的中心。標記三個螺絲孔的位置和一個小孔（提供乙太網路線通過）。接著請鑽三個 4 毫米 (mm) 的孔和 25 毫米 (mm) 的乙太網路線孔。

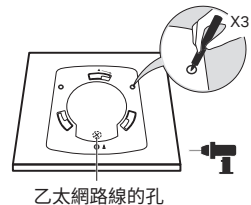

- 3 使用三個 M3x30 盤頭螺釘、墊片與翼狀核心將安裝支架固定到天花板。

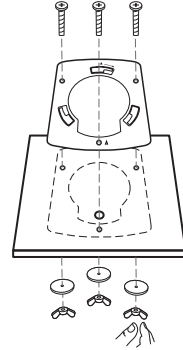

- 4 將乙太網路線穿過小孔，並將天花板瓦片重新放回原位。

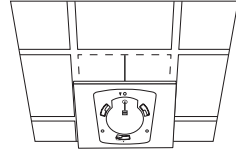

- 5 將乙太網路線連接到乙太網連接埠。透過對準 EAP/CAP 上的箭頭標誌與安裝支架上的箭頭標誌，連接 EAP/CAP 到安裝支架，然後順時針旋轉 EAP/CAP，直到它鎖定到位。

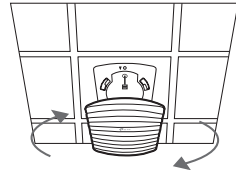

### ■ 選項三：牆面安裝

請按照下面的步驟與所提供的配件安裝 EAP/CAP：



M3×28 塑料牆錨  
(Qty.3)



M3×20 自攻螺釘  
(Qty.3)

- 1 如果您的乙太網路線穿過牆壁，您可以放置安裝支架，使網路線穿過固定孔。在牆壁上做三個螺絲孔標記，並在您標記的位置鑽 6 毫米 (mm) 的孔。

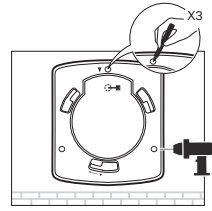

- 2 將塑料牆錨插入 6 毫米 (mm) 的孔。

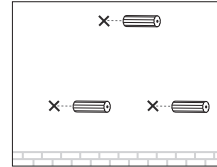

- 3 透過將自攻螺釘旋入牆錨將安裝支架固定在牆上。並確保安裝支架的肩部在外側。

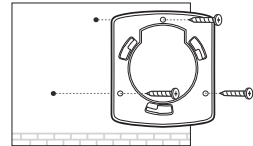

- 4 將乙太網路線連接到 EAP/CAP 的乙太網連接埠。

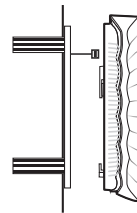

- 5 透過對準 EAP/CAP 上的箭頭標誌與安裝支架上的箭頭標誌，連接 EAP/CAP 到安裝支架，然後順時針旋轉 EAP/CAP，直到它鎖定到位。

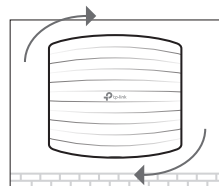

# 電力供應

## ■ 透過 PSE 設備或電源供應器進行供電

如果產品提供電源供應器，可透過 PSE 設備（例如：PoE 交換器）或電源供應器對設備供電。

### 透過 PoE 交換器

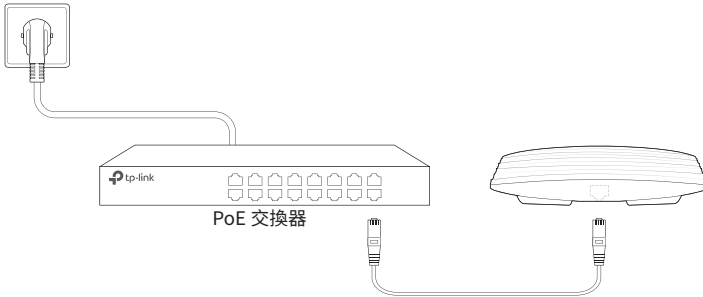

### 透過電源供應器

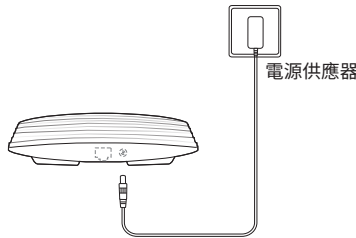

## ■ 透過 PoE 適配器供電

如果產品提供 PoE 適配器，可透過 PoE 適配器對設備供電。

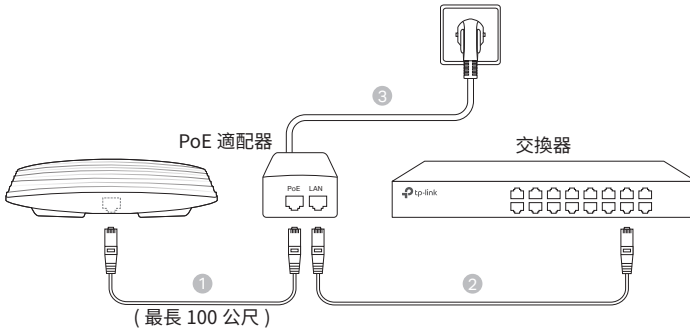

หมายเหตุ: ภาพอาจแตกต่างจากสินค้าจริง

## โครงสร้างเครือข่าย

### ■ สำหรับ EAP

โครงสร้างเครือข่ายทั่วไปสำหรับ EAP ที่แสดงอยู่ด้านล่าง

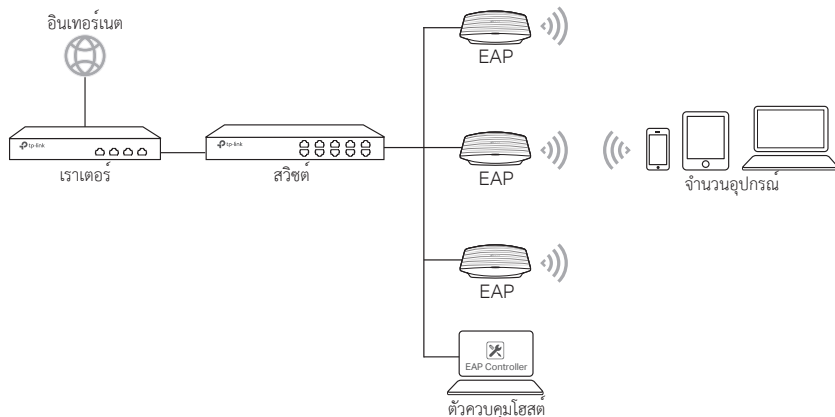

โปรแกรม EAP Controller ที่เปิดใช้งานอยู่บนคอมพิวเตอร์ สามารถทำงานบน Subnet เดียวกันหรือต่างกันได้  
คุณสามารถดาวน์โหลดซอฟต์แวร์ EAP Controller จากเว็บไซต์ของเรา <https://www.tp-link.com>

### ■ สำหรับ CAP (โหมด FIT)

โครงสร้างเครือข่ายทั่วไปสำหรับ CAP จะแสดงด้านล่าง

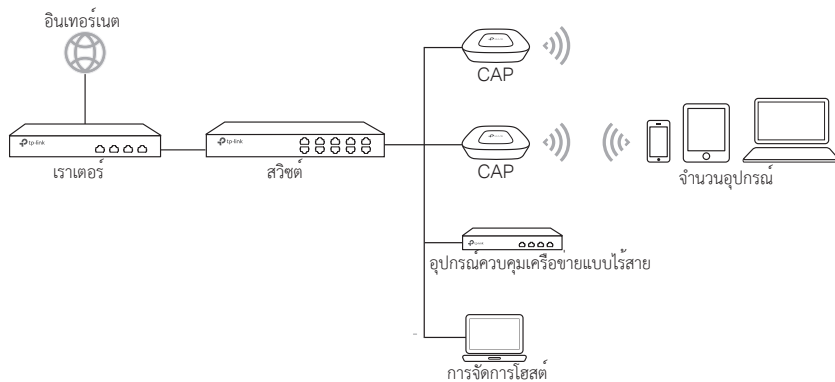

อุปกรณ์ควบคุมเครือข่ายแบบไร้สายที่สามารถอยู่ใน Subnet เดียวกันหรือแตกต่างจาก CAPs  
ซึ่งสามารถเข้าสู่อุปกรณ์ควบคุมเพื่อตั้งค่าต่างๆของ CAPs ได้

# การติดตั้งฮาร์ดแวร์

## ■ ติดตั้งกับรางฝ้าเพดาน

การติดตั้งอุปกรณ์แบบยึดรางฝ้าเพดาน สามารถติดตั้งอุปกรณ์ EAP/CAP ตามขั้นตอนที่ให้มา

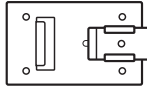

รางติดเพดาน



ขนาดของน็อต M3x6 จำนวน 5 ตัว

- 1 ตำแหน่งเพดาน T-rail Clip และผลักดันส่วนที่เคลื่อนที่เข้าหาฐาน

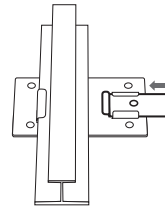

- 2 ใช้น็อตที่ให้มาติดที่ฝ้าเพดาน โดยใช้น็อตขนาด M3x6

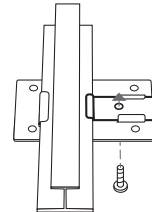

- 3 แนบยึดน็อตขนาด M3x6 เข้ากับฝ้าเพดาน

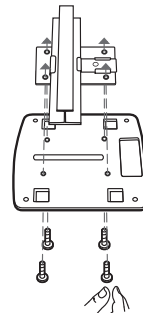

- 4 แนบ EAP / CAP ไปยึดติดโดยจัดให้ตรงกับลูกศร 1 (บน EAP / CAP) กับลูกศร 2 (บนที่ยึดติด) จากนั้นหมุน EAP / CAP ตามเข็มนาฬิกาจนล็อกเข้าไปจนสุด

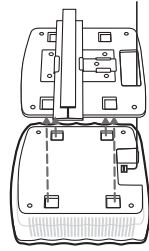

- 5 เชื่อมต่อสายไฟเข้ากับพอร์ตไอเทอร์เน็ต

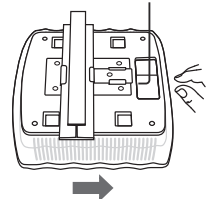

## ■ เจ็อนไซ 2 : ติดเพดาน

ทำตามขั้นตอนต่อไปนี้เพื่อติดตั้ง EAP / ฝาครอบพร้อมกับอุปกรณ์เสริมที่มีให้:



แหวนรอง  
(จำนวน 3 ชิ้น)



น๊อตขนาด M3×30  
(จำนวน 3 ชิ้น)



แป้นเกลียวทางปลา  
(จำนวน 3 ชิ้น)

- 1 เจาะฝาเพดาน

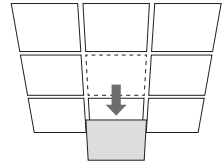

- 2 วางตัวยึดติดอยู่กึ่งกลางของแผ่นฝาเพดาน  
กำหนดสามตำแหน่งสำหรับเจาะและตำแหน่งสายอีเทอร์เน็ต  
เจาะรูขนาดเส้นผ่าศูนย์กลาง 4mm และเส้นผ่าศูนย์กลาง 25mm  
เพื่อร้อยสายอีเทอร์เน็ตที่ทำเครื่องหมายไว้

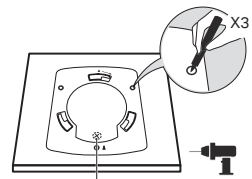

เจาะรูสำหรับสายอีเทอร์เน็ต

- 3 ยึดตัวยึดกับฝาเพดาน โดยใช้น็อตเกลียวป้อย M3X30 ใส่แหวนรองและแป้นเกลียวหางปลา

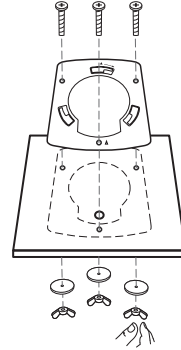

- 4 ร้อยสายอีเทอร์เน็ตผ่านรู และใส่ฝาเพดานกลับเข้าที่

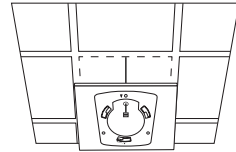

- 5 ต่อสายอีเทอร์เน็ตเข้ากับพอร์ตอีเทอร์เน็ต แบบ EAP กับชุดยึดโดยเครื่องหมายลูกศรบน EAP มีเครื่องหมายลูกศรบนที่ยึดจากนั้นหมุน EAP จนกระทั่งเข้าล็อก

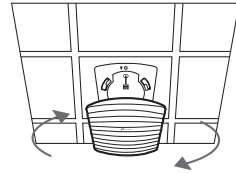

### ■ เส้นไข 3 : ติดกำแพง

ทำตามขั้นตอนต่อไปนี้เพื่อติดตั้ง EAP / ฝาครอบพร้อมกับอุปกรณ์เสริมที่มีให้:



พุกพลาสติก  
(จำนวน 3 ชิ้น)



น็อตเกลียวป้อยขนาด M3x20  
(จำนวน 3 ชิ้น)



- 1 ถ้าวางเคเบิลอีเทอร์เน็ตผ่านผนัง  
คุณสามารถวางตำแหน่งยึดเพื่อให้สายผ่านช่อง  
และตำแหน่งช่องยึดนี้จะต้องและจากนั้นเจาะรูเส้นผ่าศูนย์กลาง 6 มม  
สามตำแหน่ง

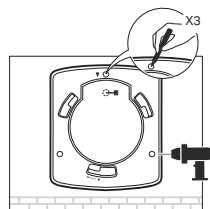

- 2 ใส่ทุกพลาสติกลงในหลุมขนาดเส้นผ่าศูนย์กลาง 6 มม

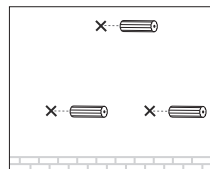

- 3 ยึดติดกับผนังโดยการขันน็อตลงในรูพลาสติก  
ตรวจสอบให้แน่ใจว่าตัวยึดติดอยู่ด้านนอก

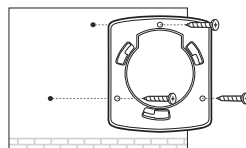

- 4 เชื่อมต่อสายอีเทอร์เน็ตเข้ากับพอร์ตอีเทอร์เน็ตที่ตัว EAP/CAP

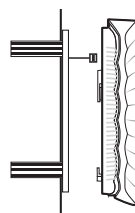

- 5 แนบ EAP / CAP ยึดติดกับขายึดโดยจัดเครื่องหมายลูกศรบน EAP /  
ฝาครอบด้วยเครื่องหมายลูกศรบนขายึดแล้วหมุน EAP / CAP  
จนจะมีการล็อกเข้าไป

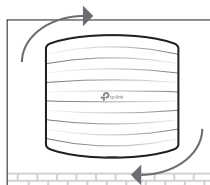

# อุปกรณ์จ่ายไฟ

## ■ อุปกรณ์ PSE หรือ Power Adapter

ถ้าผลิตภัณฑ์ที่มีอะแดปเตอร์ จะถูกจ่ายไฟผ่านอุปกรณ์ PSE (เช่นสวิตช์ PoE) หรืออะแดปเตอร์

ผ่านสวิตช์ PoE

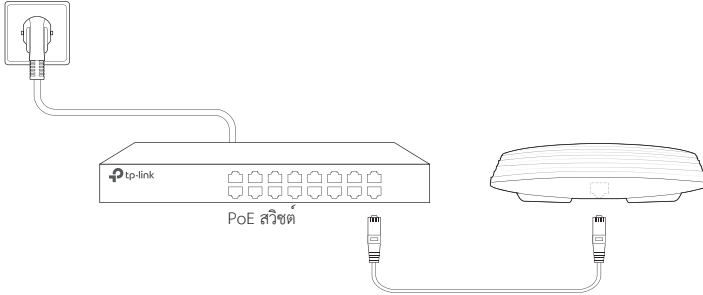

ผ่านอะแดปเตอร์ไฟฟ้า

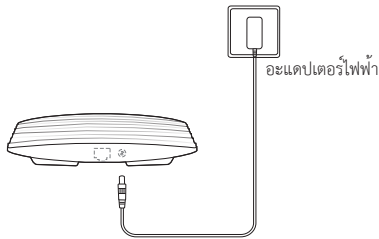

## ■ ไฟฟ้าผ่าน POE อะแดปเตอร์

ถ้าผลิตภัณฑ์ที่มีอะแดปเตอร์ POE พลังงานอุปกรณ์ผ่านทางอะแดปเตอร์ POE

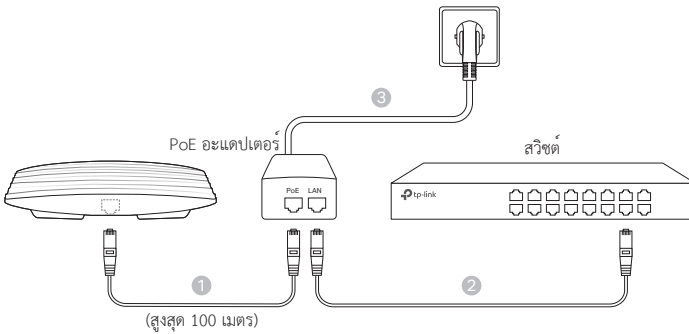

**Lưu ý:** Hình ảnh có thể khác so với sản phẩm thực tế.

# Mô hình mạng

## ■ Đối với EAP

Dưới đây là mô hình mạng phổ biến đối với EAP.

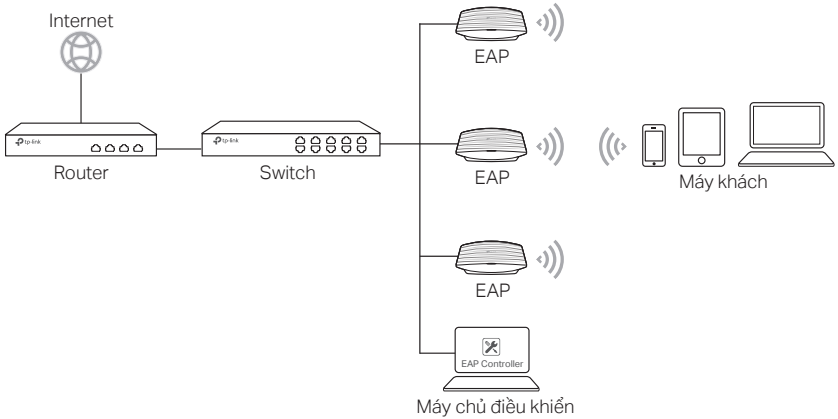

Máy tính chạy phần mềm điều khiển EAP, có thể cùng hoặc khác lớp mạng với các EAP, được sử dụng để quản lý tập trung các EAP.

Bạn có thể tải phần mềm Điều khiển EAP từ trang web của chúng tôi <https://www.tp-link.com>.

## ■ Đối với CAP (Chế độ FIT)

Dưới đây là mô hình mạng phổ biến đối với CAP.

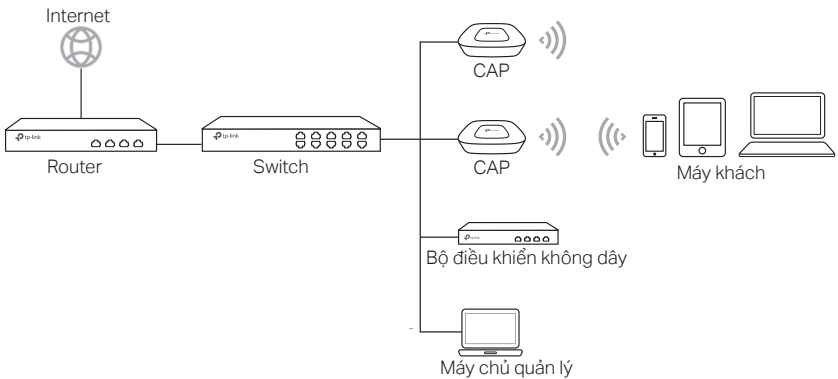

Bộ điều khiển không dây có thể cùng hoặc khác lớp mạng với các CAP. Máy chủ quản lý được sử dụng để đăng nhập vào bộ điều khiển không dây để quản lý tập trung các CAP.

# Cài đặt phần cứng

## ■ Tùy chọn 1: Gắn trần bằng đế

Gắn trần bằng đế chỉ dành cho các thiết bị với các phụ kiện bên dưới. Thực hiện theo các bước dưới đây để lắp đặt EAP/CAP với các phụ kiện kèm theo:

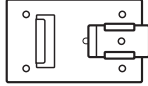

Đế gắn trần chữ T



Ốc đầu Pan M3x6 (SL 5 cái)

- 1 Gắn đế lắp trần chữ T và đẩy phần di chuyển được vào trong.

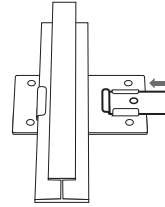

- 2 Dùng ốc đầu pan M3x6 để cố định đế lắp chữ T vào đế gắn trần.

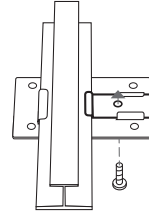

- 3 Gắn khung lắp vào đế gắn trần chữ T sử dụng 4 ốc đầu pan M3x6.

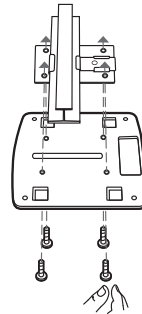

- 4 Lắp EAP/CAP vào khung lắp bằng cách canh MŨI TÊN 1 (trên EAP/CAP) với MŨI TÊN 2 (trên khung lắp), sau đó xoay EAP/CAP theo chiều kim đồng hồ cho đến khi thiết bị được khóa chặt.

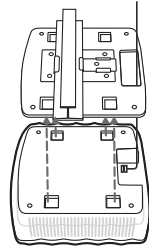

- 5 Kết nối cáp Ethernet vào cổng ETHERNET.

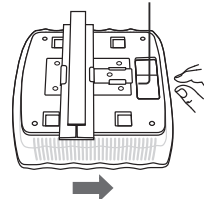

## ■ Tùy chọn 2: Gắn trần bằng giá đỡ

Thực hiện theo các bước sau để lắp đặt EAP/CAP với các phụ kiện kèm theo:



Long đèn  
(SL 3 cái)



Ốc đầu Pan M3x30  
(SL 3 cái)



Đai ốc  
(SL 3 cái)

- 1 Tháo tấm trần.

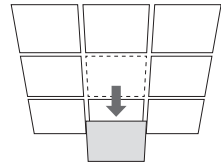

- 2 Đặt khung lắp lên giữa tấm trần. Đánh dấu 3 vị trí gắn ốc và 1 lỗ để luồn cáp Ethernet đi qua. Khoan 3 lỗ 4mm để gắn ốc và 1 lỗ 25mm để đi cáp Ethernet.

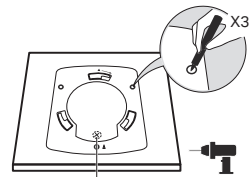

Lỗ để luồn dây cáp Ethernet.

- 3 Gắn bộ khung lắp vào tấm trần dùng 3 ốc đầu pan M3x30, long đèn và đai ốc.

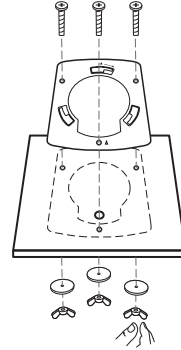

- 4 Luồn dây cáp Ethernet thông qua lỗ và gắn tấm trần trở vào vị trí cũ.

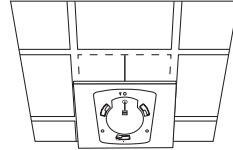

- 5 Kết nối cáp Ethernet vào cổng ETHERNET. Lắp EAP/CAP vào khung lắp bằng cách canh dấu mũi tên trên EAP/CAP với dấu mũi tên trên khung lắp, sau đó xoay EAP/CAP cho đến khi thiết bị được khóa chặt.

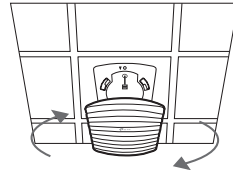

### ■ Tùy chọn 3: Gắn lên tường

Thực hiện theo các bước sau để lắp đặt EAP/CAP với các phụ kiện kèm theo:



Tích kê nhựa M3x28  
(SL 3 cái)



Ốc đầu nhọn M3x20  
(SL 3 cái)

- 1 Nếu cáp Ethernet của bạn được luồn qua tường, bạn có thể đặt khung lắp sao cho cáp xuyên qua lỗ trên khung lắp. Đánh dấu 3 vị trí gắn ốc và khoan 3 lỗ 6mm trên vị trí đã đánh dấu.

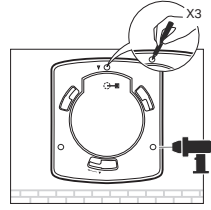

- 2 Đóng tích kê nhựa vào lỗ 6mm trên tường.

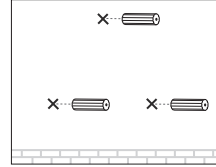

- 3 Gắn bộ khung lắp vào tường bắt ốc nhọn vào tích kê nhựa. Không vặn hết ốc vào, vui lòng chừa lại một đoạn để treo EAP.

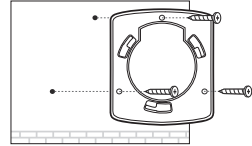

- 4 Kết nối cáp Ethernet vào cổng ETHERNET trên EAP/CAP.

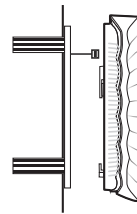

- 5 Gắn EAP/CAP vào khung lắp bằng cách canh dấu mũi tên trên EAP/CAP với dấu mũi tên trên khung lắp, sau đó xoay EAP/CAP cho đến khi thiết bị được khóa chặt.

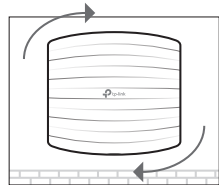

# Cấp nguồn

## ■ Cấp nguồn bằng thiết bị PSE hoặc bộ chuyển đổi nguồn

Nếu thiết bị có bộ chuyển đổi nguồn đi kèm, cấp nguồn bằng thiết bị PSE (ví dụ như switch PoE) hoặc bộ chuyển đổi nguồn.

### Thông qua Switch PoE

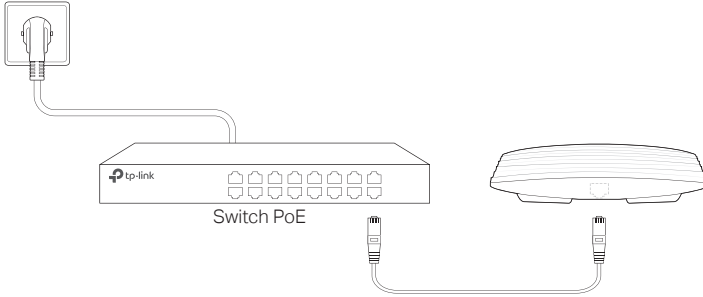

### Thông qua Bộ chuyển đổi nguồn

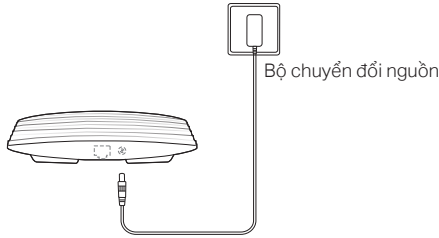

## ■ Cấp nguồn thông qua Bộ chuyển đổi POE

Nếu thiết bị có bộ chuyển đổi POE đi kèm, cấp nguồn bằng bộ chuyển đổi POE.

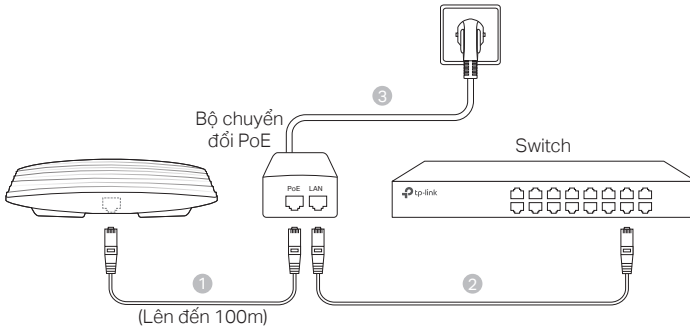



참고 : 이미지는 실제 제품과 다를 수 있습니다 .

# 네트워크 배치

## ■ EAP 사용시

EAP의 일반적인 네트워크 배치는 다음과 같습니다 .

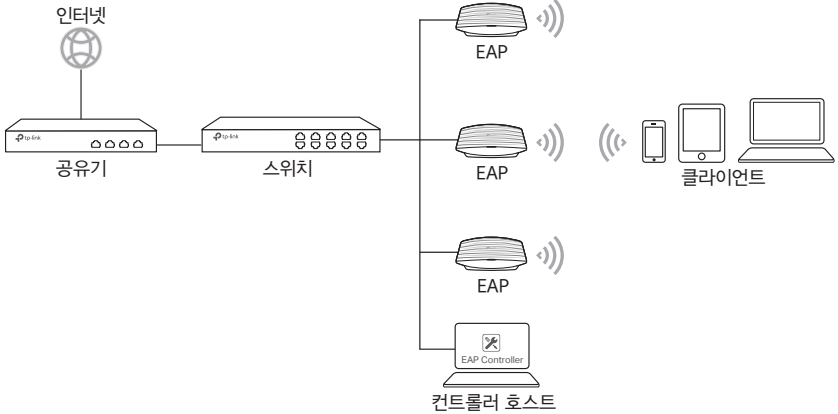

컴퓨터와 EAP 들이 동일한 서브넷에 있을때 , EAP 컨트롤러 소프트웨어를 컴퓨터에서 실행하여 EAP 들을 관리합니다 .

TP-Link 의 웹사이트 <https://www.tp-link.com> 에서 EAP 컨트롤러 소프트웨어를 다운로드할 수 있습니다 .

## ■ CAP 사용시 (FIT 모드 )

CAP의 일반적인 네트워크 배치는 다음과 같습니다 .

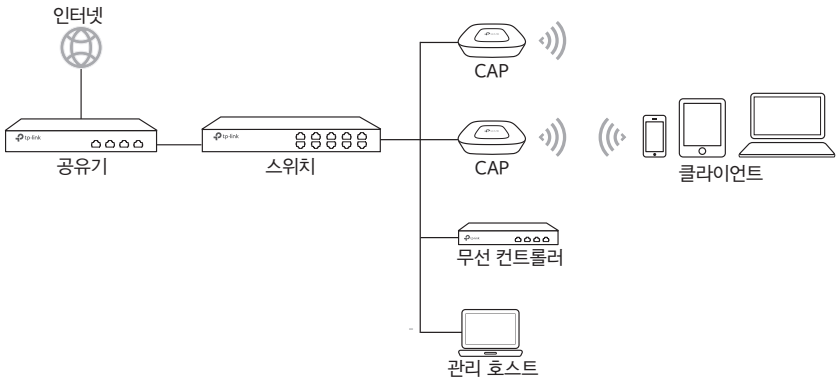

무선 컨트롤러는 CAP 와 같은 서브넷이든지 다른 서브넷이든지 상관없습니다 . 관리 호스트는 CAP 를 중앙에서 관리하기 위해 무선 컨트롤러에 로그인합니다 .

# 하드웨어 설치

## ■ 옵션 1: 천장 레일에 장착하기

장치를 천장 레일에 장착하는 경우는 다음의 약세사리가 있는 장치만 가능합니다. 아래 단계에 따라 해당 약세사리가 있는 EAP / CAP 를 천장에 설치하세요.

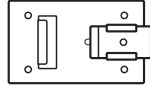

천장용 T-레일 클립



M3\*6 팬 - 헤드 나사 ( 총 수량 5 개 )

- 1 천장용 T-레일 클립을 배치하고 움직이는 부분을 레일 받침대쪽으로 밀어주십시오.

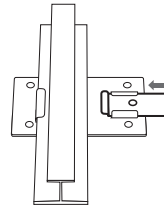

- 2 M3\*6 팬 - 헤드 나사를 사용하여 T-레일 클립을 천장에 고정하세요.

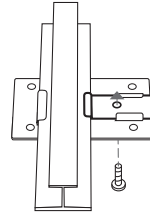

- 3 4 개의 M3x6 팬 - 헤드 나사를 사용하여 천장 T-레일 클립에 장착 브래킷을 부착하십시오.

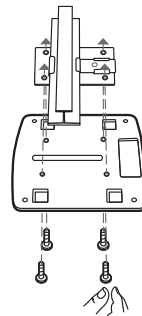

- 4 ARROW1 (EAP/CAP) 을 ARROW2( 장착 브라켓) 에 맞추고 EAP/CAP 를 장착 브라켓에 연결 한 다음 EAP/CAP 를 제자리에 잠길 때까지 시계 방향으로 돌립니다 .

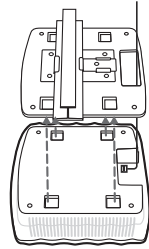

- 5 이더넷 포트에 이더넷 케이블을 연결합니다 .

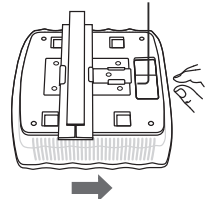

## ■ 옵션 2: 천장에 장착하기

아래의 단계에 따라 해당 액세서리가 있는 EAP/ CAP 를 설치하세요 .

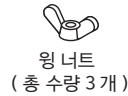
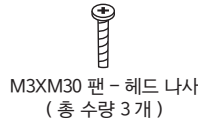
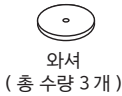

- 1 천장의 타일을 제거하세요 .

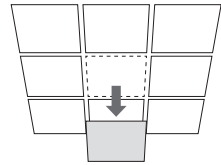

- 2 마운트 브라켓을 천장 타일의 가운데에 놓습니다 . 나사 구멍의 위치와 이더넷 케이블 구멍의 위치를 표시하십시오 . 나사 용 직경 4mm 의 구멍 3 개와 표시된 위치에있는 이더넷 케이블 용 직경 25mm 의 구멍을 뚫습니다 .

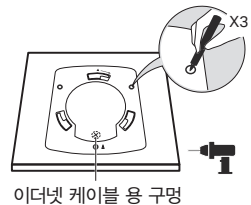

- 3 3개의 M3x30 팬-헤드 나사, 와셔 및 링 너트를 사용하여 마운팅 브래킷을 천장 타일에 고정하십시오.

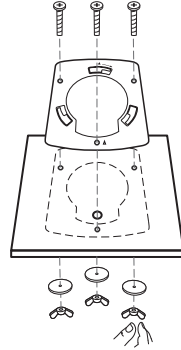

- 4 구멍을 통해 이더넷 케이블을 연결하고 천장 타일을 제자리에 다시 놓습니다.

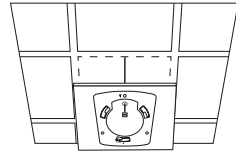

- 5 이더넷 케이블을 이더넷 포트에 연결하십시오. EAP/CAP의 화살표를 장착 브래킷의 화살표와 맞추고 EAP/CAP를 장착 브래킷에 연결 한 다음 EAP/CAP을 제자리에 고정 될 때까지 회전시키세요.

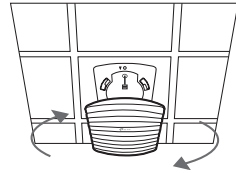

### ■ 옵션 3: 벽에 장착하기

아래의 단계에 따라 해당 액세서리가 있는 EAP/ CAP 를 설치하세요 .



M3x28 플라스틱 벽 앵커  
(총 수량 3개)



M3x20 자동 태핑 나사  
(총 수량 3개)

- 1 이더넷 케이블이 벽을 통해 연결되는 경우 고정 브라켓을 배치하여 고정 구멍을 통해 케이블 통로를 만들 수 있습니다. 나사 구멍가 들어갈 3개 위치를 표시하고 표시된 위치에 직경 6mm의 구멍 3개를 뚫습니다.

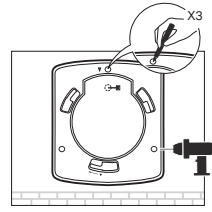

- 2 플라스틱 벽 앵커를 직경 6mm 구멍에 삽입하십시오.

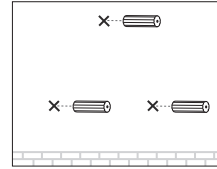

- 3 자동 태핑 나사를 앵커에 밀어 넣어 장착 브라켓을 벽에 고정시킵니다. 장착 브라켓의 솔더가 바깥쪽에 있는지 확인하십시오.

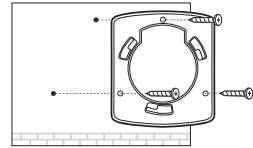

- 4 EAP/CAP의 이더넷 포트에 이더넷 케이블을 연결하세요.

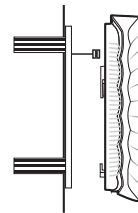

- 5 EAP/CAP의 화살표를 장착 브라켓의 화살표와 맞추고 EAP/CAP를 장착 브라켓에 연결한 다음 EAP/CAP을 제자리에 고정 될 때까지 회전시키세요.

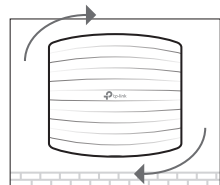

# 전원 공급

## ■ PSE 장치나 파워 어댑터를 통한 전원 공급

제품에 전원 어댑터가있는 경우 PSE 장치 ( 예 : PoE 스위치 ) 또는 전원 어댑터를 통해 장치의 전원을 켭니다 .

### PoE 스위치를 통해

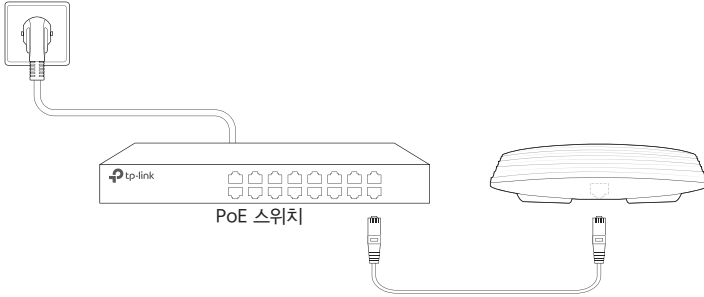

### 전원 어댑터를 통해

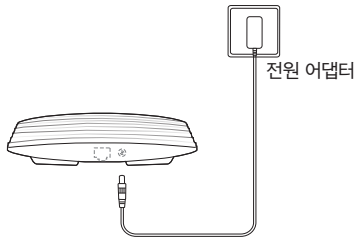

## ■ PoE 어댑터를 통해 전원 공급

제품에 PoE 어댑터가 동봉된 경우 , PoE 어댑터를 통해 전원을 공급하세요 .

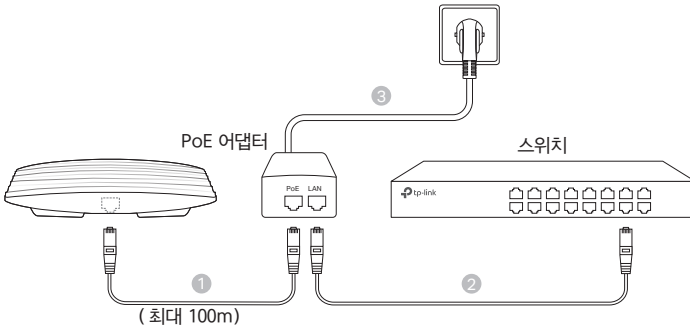

# NCC Notice

## 注意!

### 依據 低功率電波輻射性電機管理辦法

第十二條 經型式認證合格之低功率射頻電機，非經許可，公司、商號或使用者均不得擅自變更頻率、加大功率或變更原設計之特性或功能。

第十四條 低功率射頻電機之使用不得影響飛航安全及干擾合法通信；經發現有干擾現象時，應立即停用，並改善至無干擾時方得繼續使用。前項合法通信，指依電信規定作業之無線電信。低功率射頻電機需忍受合法通信或工業、科學以及醫療用電波輻射性電機設備之干擾。

# BSMI Notice

## 安全諮詢及注意事項

- 1) 請使用原裝電源供應器或只能按照本產品注明的電源類型使用本產品。
- 2) 清潔本產品之前請先拔掉電源線。請勿使用液體、噴霧清潔劑或濕布進行清潔。
- 3) 注意防潮，請勿將水或其他液體潑灑到本產品上。
- 4) 插槽與開口供通風使用，以確保本產品的操作可靠並防止過熱，請勿堵塞或覆蓋開口。
- 5) 請勿將本產品置放於靠近熱源的地方。除非有正常的通風，否則不可放在密閉位置中。
- 6) 請不要私自打開機殼，不要嘗試自行維修本產品，請由授權的專業人士進行此項工作。

## 限用物質含有情況標示聲明書

產品元件名稱	限用物質及其化學符號					
	鉛 Pb	鎘 Cd	汞 Hg	六價鉻 CrVI	多溴聯苯 PBB	多溴二苯醚 PBDE
PCB	○	○	○	○	○	○
外殼	○	○	○	○	○	○
電源供應器	—	○	○	○	○	○

備考1. "超出0.1 wt %"及"超出0.01 wt %"系指限用物質之百分比含量超出百分比含量基準值。  
備考2. "○"系指該項限用物質之百分比含量未超出百分比含量基準值。  
備考3. "—"系指該項限用物質為排除項目。

